



The Institute of Chartered Accountants of India (Setup by an Act of Parliament)



Women Members Excellence Committee

Organises

यशस्विनी - An IDOL- Live Webinar



CA. Priti Paras Savla
Chairperson, WMEC, ICAI



CA. Kemisha Soni
Vice Chairperson, WMEC, ICAI

OPPORTUNITIES FOR
WOMEN CHARTERED
ACCOUNTANTS IN
MSME SECTOR



MINISTRY OF FINANCE, Department of Revenue

CENTRAL BOARD OF DIRECT TAXES

CENTRAL BOARD OF INDIRECT TAXES & CUSTOMS



Traditional Practice

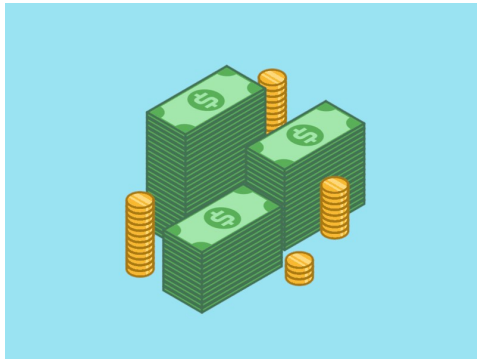

Subsidy/MSME Practice



Traditional Practice

Vs.

Non-Traditional Practice
Or
Industrial Practice

Traditional

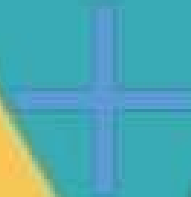

VS



Non Traditional



Non-Traditional Practice or Industrial Practice

**Ministry of Micro, Small
& Medium Enterprises
(Jitan Ram Manjhi)**



**Ministry of Commerce &
Industries
(Piyush Goyal)**



**Ministry of Textile
(Giriraj Singh)**



**Ministry of Food
Processing Industries
(Chirag Paswan)**



Non-Traditional Practice or Industrial Practice

**Ministry of New and
Renewable Energy
(Pralhad Joshi)**



**Ministry of Heavy Industries
(H.D. Kumaraswamy)**



**Ministry of Electronics
& Information
Technology
(Ashwini Vaishnaw)**



**Ministry of Agriculture
and Farmers Welfare
(Shri Shiv Singh Chouhan)**

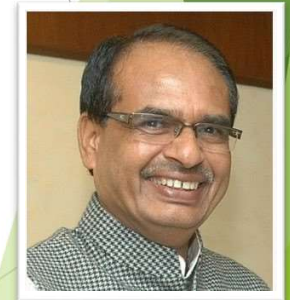

ICAI

FULL TIME	NO COP	PART TIME
1,52,490	2,48,148	7,138
CONSIDER 33% WOMEN MEMBER		
50,321	81,888	2,355

WHAT IS MSME ?

CRITERIA	MICRO	SMALL	MEDIUM
INVESTMENT IN PLANT AND MACHINERY	1 cr	10cr	50cr
ANNUAL TURNOVER	5cr	50cr	250cr

APPLICABLE TO :

MANUFACTURING ENTERPRISES

ENTERPRISES RENDERING SERVICE

MSMEs: The Backbone of India's Economic Future

Invest India

June 28, 2024

HOME > TEAM INDIA BLOGS > MSMEs: THE BACKBONE OF INDIA'S E...



Micro, small, and medium enterprises (MSMEs) are one of the driving forces propelling the Indian economy towards global greatness. As per the Udayam portal, MSMEs employ over two crore people, firmly establishing themselves as the bedrock of the economy.

Aided partly by supportive and reformatory government initiatives and technological innovations, the MSME sector has grown exponentially, accounting for ~46% of India's total exports.

**We are India's national
investment facilitation agency.**



GOVERNMENT INITIATIVES TO SUPPORT MSME GROWTH IN INDIA



The Growth Of MSMEs In India

UDYAM REGISTRATION

- Facilitate the permanent registration of MSMEs.
- There is no registration fee
- an enterprise is issued a digital certificate based on self-declaration.
- enhance the ease of doing business



भारत सरकार
Government of India
सूक्ष्म, लघु एवं मध्यम उद्यम मंत्रालय
Ministry of Micro, Small and Medium Enterprises



UDYAM REGISTRATION CERTIFICATE

NEW

Our small hands to
make you LARGE



TYPE OF ENTERPRISE

MICRO

SERVICES

UDYAM REGISTRATION NUMBER

UDYAM-MH-09-0001586

NAME OF ENTERPRISE

SOCIAL CATEGORY OF
ENTREPRENEUR

General

NAME OF UNITS

SN.	Udyog Aadhaar Memorandum	Units Name
1	MH09D0002430	MODI AND AGRAWAL

OFFICAL ADDRESS OF
ENTERPRISE

Flat/Door/Block No.	HLNO 3217/7	Name of Premises/ Building	MODI HOUSE NEAR SHERE PUNJAB HOTEL
Village/Town	DHULE	Block	DHULE
Road/Street/Lane	AGRA ROAD	City	DHULE
State	MAHARASHTRA	District	DHULE, Pin 424001
Mobile	9422285096	Email:	ghmodi@hotmail.com

DATE OF INCORPORATION /
REGISTRATION OF ENTERPRISE

24/03/2002

DATE OF COMMENCEMENT OF
PRODUCTION/BUSINESS

24/03/2002

NATIONAL INDUSTRY
CLASSIFICATION CODE(S)

SN.	NIC 2 Digit	NIC 4 Digit	NIC 5 Digit	Activity
1	69 - Legal and accounting activities	6920 - Accounting, bookkeeping and auditing activities; tax consultancy	69201 - Accounting, bookkeeping and auditing activities	Services
2	69 - Legal and accounting activities	6920 - Accounting, bookkeeping and auditing activities; tax consultancy	69202 - Tax consultancy	Services

DATE OF UDYAM REGISTRATION

28/10/2020

Disclaimer: This is computer generated statement, no signature required.
Printed from <https://udyamregistration.gov.in>

For any assistance, you may contact:

1. DIC DHULE
2. MSME-DI MUMBAI

Visit : www.msme.gov.in ; www.dcmsme.gov.in ; www.champions.gov.in



**BE A
CHAMPION
with the
Ministry of
MSME**

Follow us @minmsme & @msmechampions



भारत सरकार
Govt. of India
सूक्ष्म, लघु और मध्यम उद्यम मंत्रालय
MINISTRY OF MICRO, SMALL & MEDIUM ENTERPRISES



उद्योग आधार



Udyog Aadhaar

D

Type of Enterprise	Micro	Small	Medium
Manufacturing	A	B	C
Services	D	E	F
UAN	MH09D0002430		

Udyog Aadhaar Memorandum

- Aadhaar Number
- PAN Number
- Name of Entrepreneur
- Social Category of Entrepreneur GENERAL
- Gender Male
- Physically Handicapped No
- Name of Enterprise MODI AND AGRAWAL
- Type of Organization Partnership
- Location of Plant Details

OLD

SN	Flat/Door/Block No.	Name of Premises/Building Village	Road/Street/ Lane	Area/Locality	City	Pin	State	District
1	H. No. 3217/7	MODI HOUSE	AGRA ROAD, NEAR SHERE PUNJAB HOTEL	DHULE	DHULE	424001	MAHARASHTRA	DHULE
2	PLOT NO. 165	MATRUMANDIRAM	JYOTI NAGAR,	AURANGABAD	AURANGABAD	431105	MAHARASHTRA	AURANGABAD
3	D-114	EASTERN BUSINESS DISTRICT	NEAR MANGATRAM PETROL PUMP, L.B.S. MARG, BHANDUP (W)	MUMBAI	MUMBAI	400078	MAHARASHTRA	MUMBAI SUBURBAN
4	FLAT NO. 6	SAI SAMARTH TOWER	IN FRONT OF SHREE SHREE LAWN, ADARSH NAGAR	JALGAON	JALGAON	425001	MAHARASHTRA	JALGAON

Official Address of Enterprise H. NO. 3217/7, MODI HOUSE, AGRA ROAD, DHULE- 424001, TALUKA AND DISTRICT DHULE

- District DHULE State MAHARASHTRA PIN 424001
Mobile No: 9923205127 Email: patilarjun31@gmail.com
- Date of commencement 24/03/2002
- Previous Registration details-if any ::
- Bank Details IFS Code UTIB0000472
Bank Account: 472010200005838
- Major Activity SERVICES

SN	NIC 2 Digit	NIC 4 Digit	NIC 5 Digit Code	Activity Type
16	69 - Legal and accounting activities	6920 - Accounting, bookkeeping and auditing activities; tax consultancy	69201 - Accounting, bookkeeping and auditing activities	Services
2	69 - Legal and accounting activities	6920 - Accounting, bookkeeping and auditing activities; tax consultancy	69202 - Tax consultancy	Services

- Persons employed 25
- Investment (Plant & Machinery / Equipment's) 10(Rs. In Lakhs)
- District Industry Centre DHULE

Declaration

I hereby declare that information given above is true to the best of my knowledge. Any information, that may be required to be verified, shall be provided immediately before the concerned authority.

MyMsme Mobile App (Beta Version) is available now for download. <https://play.google.com/store/apps/details?id=msme.my.msme>

The Udyam certificate enables *MSMEs* to access several government initiatives such as:



Credit Guarantee Fund Trust for Micro and Small Enterprises (CGTMSE)

- ▶ Help MSMEs access bank credit
- ▶ MSMEs can access collateral-free loans up to INR 5 Cr,
- ▶ With a guaranteed coverage of up to 85% for multiple loan categories under CGTMSE.
- ▶ Implement by GOI and SIDBI

The Prime Minister Employment Generation Programme (PMEGP)

- ▶ Established to create employment opportunities for MSMEs in India
- ▶ Provides loans and working capital
- ▶ INR 25 Lakh for manufacturing
- ▶ INR 10 Lakh for service sector
- ▶ Implemented by **Khadi and Village Industries Commission (KVIC)** at national level
- ▶ State and District level :
 - **State Khadi and Village Industries Boards (KVIBs)**
 - **District Industries Centres (DICs)**
 - **Banks**

Raising and Accelerating MSME Performance (RAMP)

- ▶ Launched in July 2022
- ▶ An outlay of INR 6000 Cr has been assigned for five years to ensure the implementation.
- ▶ RAMP aims to:
 - ▶ Aims to improve the access of MSMEs to both the global market and credit.
 - ▶ Strengthening the Receivable Financing Market for MSMEs
 - ▶ Enhancing the effectiveness of **Credit Guarantee Trust for Micro & Small Enterprises (CGTMSE)**
 - ▶ **Promoting women owned MSEs**
 - ▶ Reducing the incidence of delayed payments to MSEs

The Role of MSMEs in Building a Sustainable and Inclusive Economy

MSMEs' role in fostering sustainability and inclusivity in the Indian economy is irrefutable. 20.5% of the MSMEs registered on the Udyam Registration Portal are led by women, accounting for 18.73% of the total employment generated by Udyam-registered MSMEs.

While the numbers speak for themselves, to ensure the growth of the sector and the economy remains inclusive, equitable, and sustainable, the Ministry of MSMEs has undertaken various initiatives to foster MSMEs that value these goals. For example, the Credit Guarantee Scheme for Micro & Small Enterprises offers a 10% concession in annual guarantee fees and up to 85% guarantee coverage for female entrepreneurs. Meanwhile, the SAMARTH initiative provides more than 7500 women from rural and sub-urban areas with skill development and market development assistance to encourage female entrepreneurship.

On the other hand, the MSME Sustainable (ZED) Certification Scheme encourages MSMEs to streamline their processes to transition towards sustainability and reduce environmental costs. Furthermore, the scheme offers a 100% subsidy for ZED Certification for Women-owned MSMEs.

ORGANISATIONS ATTACHED TO MSME

**KHADI VILLAGE
INDUSTRIES
COMMISSION
(KVIC)**



**National Small
Industries
Corporation
Limited (NSIC)**



**COIR
BOARD**

कामये दुखतमानाम्।
प्राणिनाम् आर्तिनाशनम्॥



राष्ट्रीय लघु उद्योग निगम लिमिटेड
The National Small Industries Corporation Ltd.

Logo of National Institute for Micro,
Small and Medium Enterprises

**NATIONAL
INSTITUTE FOR
MICRO, SMALL AND
MEDIUM
ENTERPRISES**



The Institute of Chartered
Accountants of India
(Setup by an Act of Parliament)

COMMITTEE ON MSME & START-UP



CA. Ranjeet Kumar
Agarwal,
President, ICAI



CA. Dheeraj K Khandelwal
Chairman, Committee on MSME & Start-up

- An Initiative of the Committee on MSME & Start-Up :-
 - Expression of Interest as Resource Person with respect to Start-Ups
 - Expression of Interest as Resource Person with respect to MSMEs



The Institute of Chartered
Accountants of India

COMMITTEE ON
MSME AND STARTUP



Supported by



सत्यमेव जयते



MINISTRY OF MICRO, SMALL & MEDIUM ENTERPRISES
GOVERNMENT OF INDIA

ICAI MSME YATRA

ICAI as Swift Responder to MSME Needs



Jointly Organised by: Committee on MSME and Startup, ICAI &
Committee for Development of International Trade, Services & WTO, ICAI

75

DAYS
PROGRAMMES
CITIES

This Programme will be kicked off
through the branches/ RCs



18th Aug. to 18th Nov., 2022

Programme is also Supported by





The Institute of Chartered Accountants of India
(Set up by an Act of Parliament)
Professional Skills Enrichment Committee, ICAI



International MSME Day

Entrepreneurship Skills for Chartered Accountants

Jointly organised by:
Professional Skills Enrichment Committee (PSEC), ICAI &
Committee on MSME & Startup, ICAI

Hosted by
ICAI Vijayawada Branch (SIRC)



CA. Ranjeet Kumar Agarwal
President, ICAI



CA. Charanjot Singh Nanda
Vice-President, ICAI



26th June 2024 (Wednesday)



10:00 AM to 5:00 PM



ICAI Bhawan
Vijayawada

Chief Guest



Sri Andukuri Sudhakar
Joint Director of Industries & General Manager
District Industries Centre, NTR District

Guest of Honour



Sri B. Rajasekhar
General Secretary, AP Chambers



CA S. Pannaraj
Chairman MSME Committee
Past chairman SIRC

CPE : 6 Hrs



ADVANTAGE ANDHRA PRADESH

WHERE ABUNDANCE MEETS PROSPERITY



GLOBAL INVESTORS SUMMIT 2023

March 03 – 04, 2023 | Andhra University College of Engineering, Visakhapatnam



K INVEST
KARNATAKA

BUILD FOR THE WORLD

Invest
Karnataka
2022

**Global
Investors
Meet**

Bangalore Palace,
Bengaluru
NOV 2 - 4

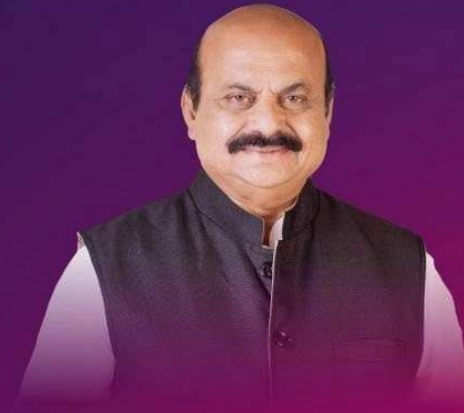

Shri. Basavaraj S. Bommai
Hon'ble Chief Minister



Dr. Muruges R. Nirani
Hon'ble Minister for Large and
Medium Industries



vibrant

10-12 Jan

GUJARAT 2024

Gateway to the Future | 10th Global Summit



सत्यमेव जयते

Government
of Rajasthan



Invest Rajasthan

24-25 Jan 2022 ▶ JAIPUR

Committed. Delivered.

Uttarakhand

Global Investors Summit-2023



Indian Economy



INDIA'S AIM OF BECOMING \$ 5 TRILLION ECONOMY

- In 2024 India has become a \$ 4.11 trillion economy.
- Has added 1.27 Trillion US dollars in the last 5 years.
- Vision to become a \$ 5 trillion economy by **2024-25** and touch **\$7 trillion by 2030.**
- It is challenging but it is realizable.
- Red carpet rather than red tap to investment.
- Single window clearance systems.

ATMANIRBHAR BHARAT ABHIYAN

- ▶ VOCAL FOR LOCAL
- ▶ LOCAL FOR GLOBAL
- ▶ Govt. of India announced a special economic package of Rs. 20.90 Lac Crore.
- ▶ Defense Ministry introduces “Impact Embargo” on 101 item to boost Atmanirbhar Bharat.





MINISTRY OF MICRO, SMALL & MEDIUM ENTERPRISES
GOVERNMENT OF INDIA

Ministry of Micro Small and Medium Enterprises
(Government of India)

MSME SAMADHAAN- Delayed Payment Monitoring System



English ▾

Case Filing for Entrepreneur/MSE Units

Check Case Status

Factsheets ▾

Officer Login



MSME SAMADHAAN

NEW "MSME Units are requested to Onboard on TReDS Platform. Three available platforms are 1. www.rxil.in 2. www.m1xchange.com 3. www.invoicemart.com "

Applications & Cases status of Micro and Small Units (MSEs)

1,97,870

Applications filed by MSEs

[More info](#)

18233

Applications Mutually Settled

[More info](#)

49700

**Applications yet to be viewed by
MSEFC Council**

[More info](#)

52658

**Applications Rejected by MSEFC
Council**

[More info](#)

37736

Cases Disposed by MSEFC Council

[More info](#)

39543

**Cases Currently under
Consideration by MSEFC**

[More info](#)

TReDS

[Home](#)[TReDS](#)

TReDS

TReDS is an electronic platform for online discounting of bills of MSMEs for supplies to large Corporates. It addresses the issue of delayed payments to MSMEs. Three TReDS platforms are presently operational in India. Receivables Exchange of India Ltd (RXIL), a joint venture of SIDBI and NSE operates one of the TReDS platform. The other two Platforms are M1xchange and Invoicemart. TReDS enables the MSMEs in securing financial assistance digitally at competitive terms and without any collateral security, based on the invoices / bills for supplies to large corporates. This also improves the liquidity for MSMEs resulting in better cashflow management.





Ministry of Micro, Small and Medium Enterprises
Government of India

MSME SAMBANDH



Public Procurement Policy Monitoring Portal

WHAT WE CAN DO

- ▶ We can become a facilitator for the enterprises who can help them to know about government schemes and subsidies related to their business
- ▶ We can provide them a complete package where all document work related to organisations of their business will be done by us. Eventually, it will lead to traditional work as well.

Why CA should do this work

- ▶ Section 35 AD- Allows deductions of certain expenses incurred by a specified business.
- ▶ Section 80IAC - 100% tax deductions for eligible startups involved in innovation, development, and scalable business models

TYPE OF WORK THAT CAN BE DONE REMOTELY



HOW TO GET CLIENTS

WE NEED TO NETWORK

There is a special post for women on board

- ▶ CHAMBER OF COMMERCE
- ▶ INDUSTRY ASSOCIATION
- ▶ Get associated/ Network with CA Firms who are providing MSME Service.



LOOK FOR WOMEN ENTERPRENUERS AND GIVE THEM CONSULTANCY



STAND UP INDIA SCHEME



Entrepreneurship support for women and SC & ST communities

Stand-up India Scheme facilitates bank loans between Rs. 10 lakh and Rs. 1 Crore

[Click here for Handholding Support Or Apply for a loan](#)

Announcement - (i) Margin Money reduced from upto 25% to upto 15% of project cost, (ii) Activities allied to agriculture are also eligible now.



258815
Total Applications



₹ 60869.29 Cr
Total Amount



235958
Sanctioned Applications



₹ 53516.25 Cr
Sanctioned Amount



24613
Handholding Agencies



4247
HHA Requests



82
Lenders Onboarded



151259
Branches Connected

Stand-Up India Ecosystem



» Stand-Up India Scheme Features

⊕ Title of the Scheme

Title of the Scheme

Stand-Up India Scheme for financing SC/ST and/or Women Entrepreneurs.

⊕ Objective

Objective

The objective of the Stand-Up India scheme is to facilitate bank loans between 10 lakh and 1 Crore to at least one Scheduled Caste (SC) or Scheduled Tribe (ST) borrower and at least one woman borrower per bank branch for setting up a greenfield enterprise. This enterprise may be in manufacturing, services, agri-allied activities or the trading sector. In case of non-individual enterprises at least 51% of the shareholding and controlling stake should be held by either an SC/ST or Woman entrepreneur.

⊕ Eligibility

Eligibility

1. SC/ST and/or woman entrepreneurs, above 18 years of age.
2. Loans under the scheme is available for only green field project. Green field signifies, in this context, the first time venture of the beneficiary in the manufacturing, services, agri-allied activities or the trading sector.
3. In case of non-individual enterprises, 51% of the shareholding and controlling stake should be held by either SC/ST and/or Women Entrepreneur.
4. Borrower should not be in default to any bank/financial institution.

⊕ Nature of Loan

Nature of Loan

Composite loan (inclusive of term loan and working capital) between 10 lakh and upto 100 lakh.

⊕ Purpose of Loan

Purpose of Loan

For setting up a new enterprise in manufacturing, services, agri-allied activities or the trading sector by SC/ST/Women entrepreneur.

⊕ Size of Loan

Size of Loan

Composite loan of 85% of the project cost inclusive of term loan and working capital. The stipulation of the loan being expected to cover 85% of the project cost would not apply if the borrower's contribution along with convergence support from any other schemes exceeds 15% of the project cost.

⊕ Interest Rate

⊕ Security

⊕ Repayment

⊕ Working Capital

⊕ Margin Money

Interest Rate

The rate of interest would be lowest applicable rate of the bank for that category (rating category) not to exceed (base rate (MCLR) + 3%+ tenor premium).

Security

Besides primary security, the loan may be secured by collateral security or guarantee of Credit Guarantee Fund Scheme for Stand-Up India Loans (CGFSIL) as decided by the banks.

Repayment

The loan is repayable in 7 years with a maximum moratorium period of 18 months.

Working Capital

For drawal of Working capital upto 10 lakh, the same may be sanctioned by way of overdraft. Rupay debit card to be issued for convenience of the borrower.

Working capital limit above 10 lakh to be sanctioned by way of Cash Credit limit.

Margin Money

The Scheme envisages 15% margin money which can be provided in convergence with eligible Central / State schemes. While such schemes can be drawn upon for availing admissible subsidies or for meeting margin money requirements, in all cases, the borrower shall be required to bring in minimum of 10% of the project cost as own contribution.

STAND-UP INDIA SCHEME WOULD BE OPERATED BY ALL THE BRANCHES OF SCHEDULED COMMERCIAL BANKS IN INDIA.



भारत सरकार
GOVERNMENT OF INDIA

वाणिज्य एवं उद्योग मंत्रालय
MINISTRY OF COMMERCE AND INDUSTRY



Our Toll Free Number : 1800 115 565 (10:00 AM to 05:30 PM)

#startupindia



Department for Promotion of Industry and Internal Trade
Ministry of commerce and Industry
Government of India



ENGLISH

Search here



Login

Register

About

Recognition

Funding

Schemes & Policies

Market Access

Marquee Initiatives

Resources

Get Featured

Network



FEMALE

FFOUNDERS

Women Trailblazing Innovation

Women Entrepreneurship in India



Past/Completed Programs



Virtual Incubation Program for Women Ent...



Learning Program for Women in Science an...



Accelerating Women Entrepreneurs Program

WOMEN ENTREPRENEURS



WOMEN CA ENTREPRENEUR



AKRITI CHOPRA
Co- founder Zomato

NAMITA THAPAR
Executive Director of Emcure
Pharmaceuticals



VISHAKHA MULYE
CEO Aditya Birla Capital Limited

How to get in to MSME practice

- ▶ Stay updated - latest news, projects, budget speech
- ▶ Visit MSME Website
- ▶ Visit Invest India website
- ▶ Certificate course by ICAI on MSME



Pradhan Mantri **KUSUM** Scheme





PM-KUSUM (Pradhan Mantri Kisan Urja Suraksha evam Utthaan Mahabhiyan) Scheme is aimed at ensuring energy security for farmers in India, along with honouring India's commitment to increase the share of installed capacity of electric power from non-fossil-fuel sources to 40% by 2030 as part of Intended Nationally Determined Contributions (INDCs).

Components of PM-KUSUM Scheme

The PM-KUSUM Scheme was launched in 2019 with 3 components:

- ▶ **Component-A:** For Setting up of 10,000 MW of Decentralized Grid Connected Renewable Energy Power Plants on barren land. Under this component, renewable energy based power plants (REPP) of capacity 500 kW to 2 MW will be setup by individual farmers/ group of farmers/ cooperatives/ panchayats/ Farmer Producer Organisations (FPO)/Water User associations (WUA) on barren/fallow land. These power plants can also be installed on cultivable land on stilts where crops can also be grown below the solar panels. The renewable energy power project will be installed within five km radius of the sub-stations in order to avoid high cost of sub-transmission lines and to reduce transmission losses. The power generated will be purchased by local DISCOM at pre-fixed tariff
- ▶ **Component-B:** For Installation of 17.50 Lakh stand-alone solar agriculture pumps. Under this Component, individual farmers will be supported to install standalone solar Agriculture pumps of capacity up to 7.5 HP for replacement of existing diesel Agriculture pumps / irrigation systems in off-grid areas, where grid supply is not available. Pumps of capacity higher than 7.5 HP can also be installed, however, the financial support will be limited to 7.5 HP capacity
- ▶ **Component-C:** For Solarisation of 10 Lakh Grid Connected Agriculture Pumps. Under this Component, individual farmers having grid connected agriculture pump will be supported to solarise pumps. The farmer will be able to use the generated solar power to meet the irrigation needs and the excess solar power will be sold to DISCOMs at pre-fixed tariff

It is notable that the scope of the PM-KUSUM Scheme was modified based on the learning from the first year of the implementation.



MNRE : Ministry of New and Renewable Energy (MNRE)

CENTRAL FINANCIAL ASSISTANCE (CFA)/ STATE GOVERNMENT SUPPORT

- ▶ **Component-A:** Procurement Based Incentive (PBI) @ 40 paise/kWh or Rs. 6.60 lakhs/MW/year, whichever is less, will be provided for the first five years by MNRE to DISCOMs, for buying the power from farmers/developers
- ▶ **Component-B & C:**
 - ▶ CFA of 30% of the benchmark cost or the tender cost, whichever is lower. State Government subsidy 30%; Remaining 40% by the farmer
 - ▶ In North Eastern States, Sikkim, J&K, Himachal, Uttarakhand, Lakshadweep and A&N Islands, CFA of 50%, State Government subsidy 30%, Remaining 20% by the farmer

CIRCULAR ECONOMY

"India is making the circular economy a major tool for urban development." Prime Minister Narendra Modi, Post-budget webinar speech, 2023.

Some of India's shocking statistics regarding waste management.

India ranks seventh globally in Solid Waste Generation(SWG)

- The present rate of SWG in India is 0.34 kg per capita per day, which is expected to increase to 0.7 kg per day by 2025.
- India will generate 165 million tonnes of waste by 2030.
- Out of 8 million tonnes of plastic waste in the world's oceans, the Meghna-Brahmaputra-Ganges river system dumps close to 73 thousand tons, making it the 6th most polluting river system contributing to marine plastic waste in the world.

Circular economy

Circular economy-based development approach is one of the key strategies being adopted for achieving the 2030 Agenda for Sustainable Development Goals (SDGs).

Material consumption at the urban level alone is expected to climb from 40 billion tonnes in 2010 to 90 billion tonnes in 2050, with the primary driver being the demand for construction materials.^[12]

The linear economy



Overview of Indian Waste Sector



Due to the massive population, the total waste generated in India is more than 168,403.24 TPD, because of which India ranks seventh globally in SWG



Present rate of SWG in India is 0.34 kg per capita per day, which is expected to reach up to 0.7 kg per day by 2025



Annual greenhouse gas emissions from MSW are expected to go up to 41.09 million tonnes by 2030.



India will generate 165 million tonnes of waste by 2030 and 436 million tonnes by 2050.

Waste generated among G20 countries (in million tons/year)

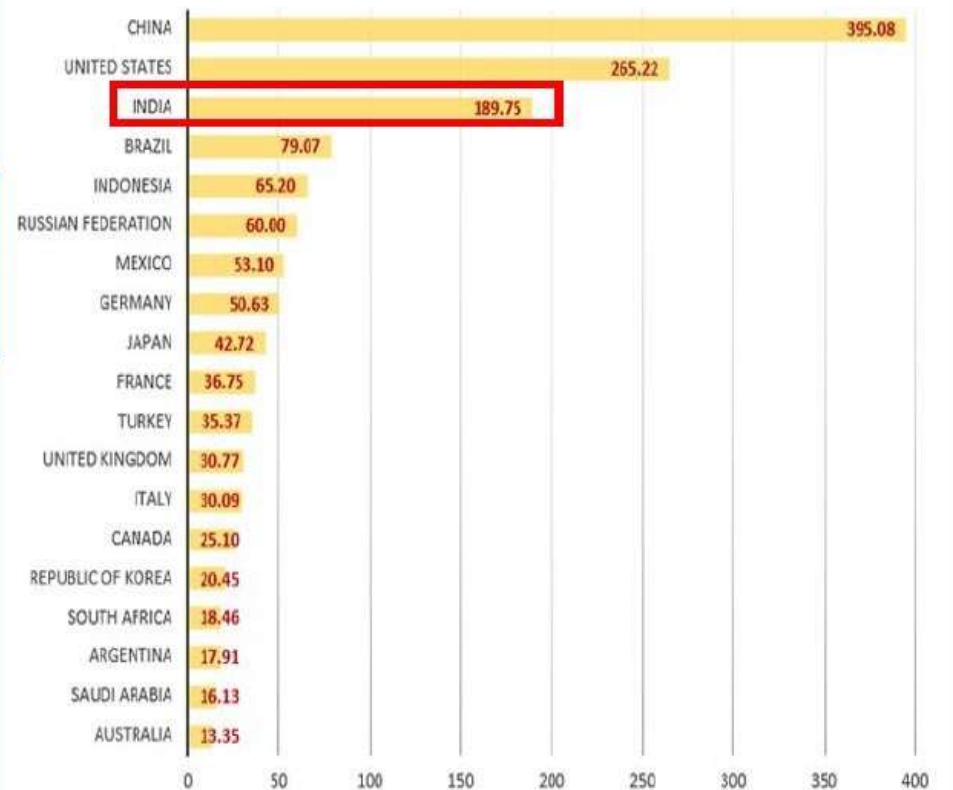

<https://mohua.gov.in/pdf/627b8318adf18Circular-Economy-in-waste-management-FINAL.pdf> ³

Value Realization Potential from Circularity

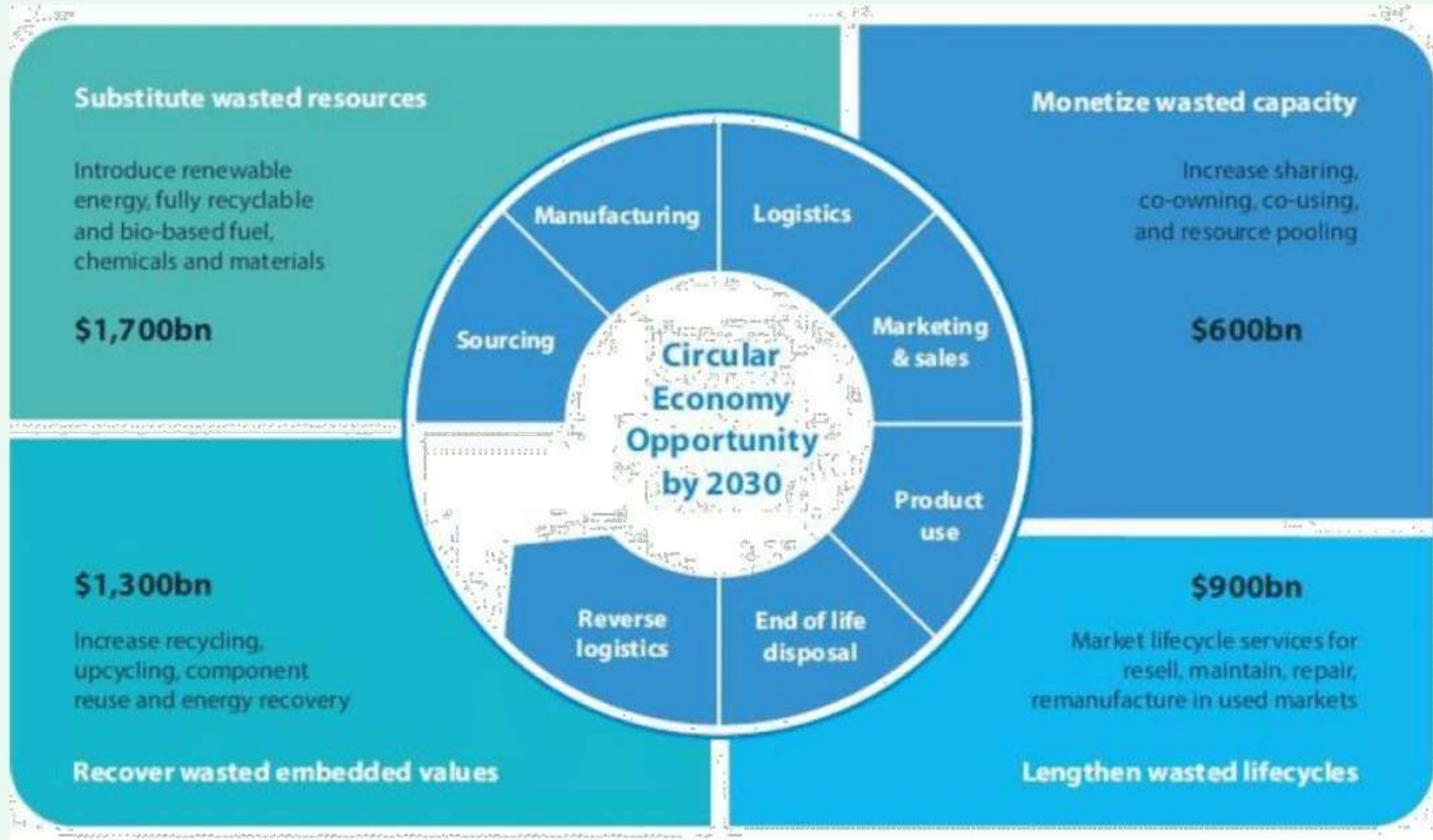

Source-Accenture 2019

Revenue Generation in Circular Economy

Compost and Bio-CNG

365 crores and `1,679 crores per annum respectively



Treated sludge and wastewater

6,570 crores and 3285 crores respectively

C&D

`416 crores per annum



Dry recycling

11,836 crores per annum

Focus areas in residual wastes

Municipal solid waste (Dry and wet)

Biomedical waste

Hazardous waste

C&D waste

E-waste

Plastic waste

Municipal wastewater

Municipal sewage sludge

End-of-life vehicles



• Business models for circular economy •

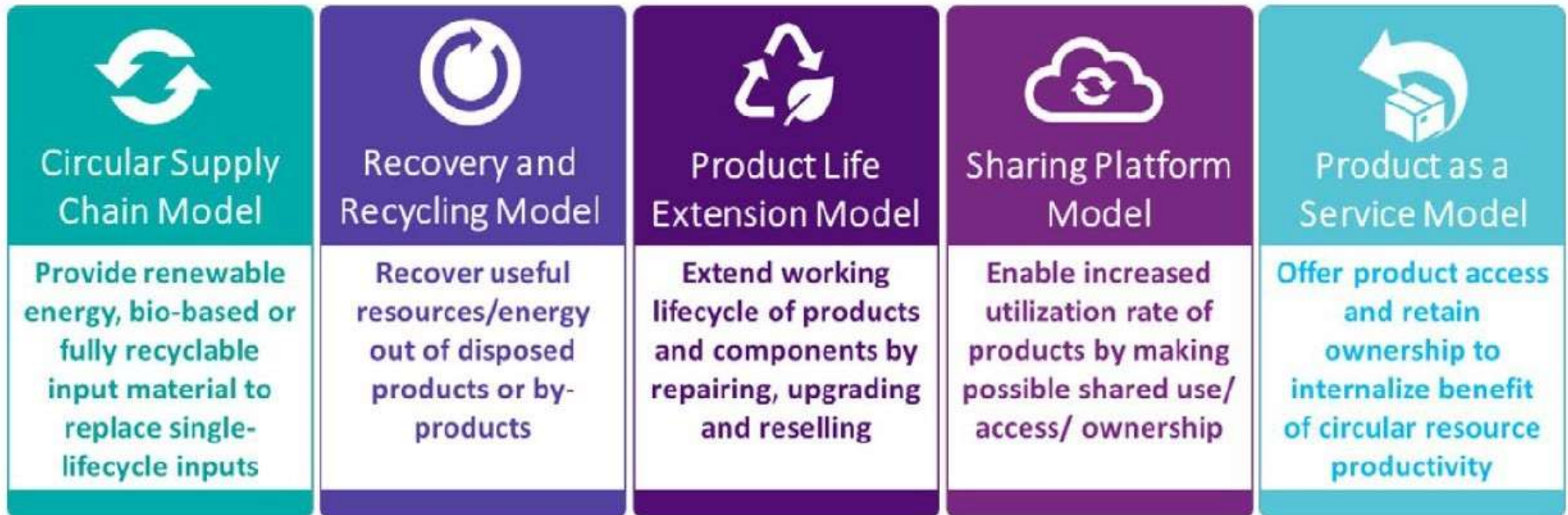

Savings from circular economy are estimated at US\$ 624 billion in year 2050, for the current development trend (KPMG study)

• Circular Economy: Wet Waste Management •

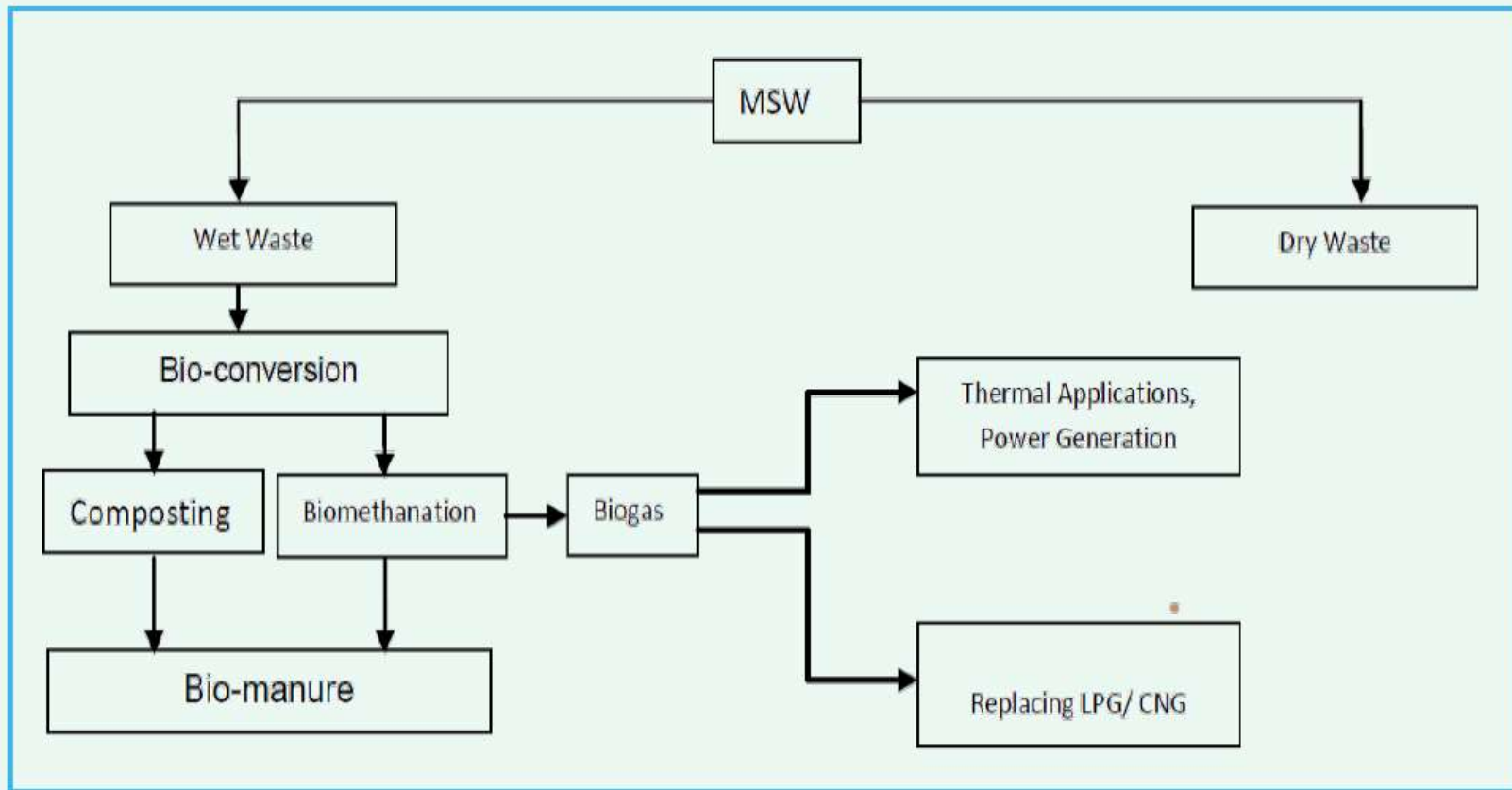

Policy Interventions – Wet Waste

Compost

Market Development Assistance of ₹1,500 per tonne compost by M/o Chemicals & Fertilizers

Waste to Energy

Financial Assistance as follows:

Biogas

capital subsidy of ₹1 crore per 12000m³ biogas/day [up to Rs.10 crore/project]

Power projects

subsidy of ₹3 crore per MW [up to ₹10 crore/project]

Bio-CNG

subsidy of ₹4 crore for 4800kgs/day of CBG generated per day [up to ₹10 crore/project].

Existing biogas units switching to CBG

subsidy of ₹3 crore.

Govt Initiatives

- Swachh Bharat (Clean India) Mission, which aims to provide access to solid and liquid waste management treatment to all villages, cities, and states.
- ‘Waste to Wealth’ initiative - working to identify, develop, and deploy technologies to treat waste to recycle materials, generate energy, and extract resources of value.
- As initiated by CPCB, an MIS portal for fetching the information from grassroots level will help to aggregate the information at any level and also to answer questions like who generate, what type and what treatment is being given.

Circular Economy CELL

 National Portal Of India



NITI Aayog

Sitemap



About Us

Cooperative Federalism

Competitive Federalism

Key Initiatives

Verticals

Publications

Disclosures & RTI

Work@NITI

VERTICALS

Vertical

Cell

> **Circular Economy Cell**

> Communication

> Library

New Arrivals

> North East Forum

> Voluntary Action Cell

Mission

FREQUENTLY VISITED



CIRCULAR ECONOMY CELL

Overview



ENERGY EFFICIENCY

AI | SATURDAY | 6 JULY 2024 | WWW.ECONOMICTIMES.COM

Economy: N

Interest Subvention Likely to Push Energy Efficiency Among MSMEs

Scheme likely to get ₹2,000 cr allocation

Shilpa Samant
@timesofindia.com

New Delhi: India could offer support to businesses, including micro, small, and medium enterprises (MSMEs), to deploy energy efficient technologies, people familiar with the development told ET.

The power ministry has begun discussions on offering interest subvention under the Assistance in Deploying Energy Efficient Technologies in Industries & Establishment (ADEETIE) Scheme for adoption of energy efficient technologies, people aware of the development said.

The Bureau of Energy Efficiency's ADEETIE scheme is an online facilitation centre for encouraging and up-scaling energy efficiency financing.

Featuring Efficiency

- Interest subvention for efficiency
- Support could be in phases
- Focus on MSMEs
- Energy saving amid rising energy demand
- Financial support to cut the cost of new tech
- May be linked with threshold energy savings



Typically, funding for tech upgrades is expensive for MSMEs. "To make India energy efficient and for sustainable development, it is important that the MSME sector adopt the green and efficient manufacturing processes," the Bureau of Energy Efficiency had said earlier. The government is keen to bring down this cost to help the sector adopt more new technologies, which may be expensive.

The scheme is likely to be designed in a manner that gives higher interest subvention for more efficiency and energy saving.

Some of such technologies could be automation and control systems for better resource utilization and loss reduction, combustion control systems for boilers, pocket ventilation systems, air-dyeing technology, methane capture technology,

among many others.

The allocation for interest subvention is likely to be to the tune of ₹2,000 crore, said an official.

"The scheme could be in phases and in the first phase it could be ₹1,000 crore. Based on the response there could be another tranche. It is being discussed," one of the people said.

MSMEs need support to adopt new technologies and once those technologies have got scale, the financial support can be withdrawn, another person said. The energy efficient technologies may be linked with certain threshold energy savings. Energy efficiency has been at the forefront of the power as well as renewable energy ministries in the wake of rising consumption in the country.

The proposal to offer financial support to MSMEs and other establishments has been in the works for some time and may finally be taking shape, according to the persons.

LATEST NEWSPAPER ARTICLE

n the **Guard Against Misadventure: RBI** >> 9

For Micro, Small & Medium Cos, a Major Funding Boost

Interest relief, loan guarantees, other financing provisions may figure in new ₹10,000cr scheme



Suryash Kumar

New Delhi: The upcoming budget could unveil a scheme aimed at bridging the credit gap and other financing issues for the micro, small and medium enterprises (MSME) sector, said people familiar with deliberations. While the contours of the scheme are yet to be finalised, it may involve an outlay upwards of ₹10,000 crore, they said.

Interventions being examined included interest subvention for working capital, credit guarantees, refinancing and some form of support towards equity, they said, adding that a special window for women entrepreneurs was also being considered.

A final decision will be taken closer to the budget, which is to be presented on July 23.

"Low-cost funding still remains an issue for MSMEs... The idea is to ease credit access to the sector," said one of the people cited above. "This could bring significant sections... into the fold of the formal economy." The idea is to provide additional support for collateral-free lending to help the sector grow.

According to a parliamentary standing committee report, the MSME sector contributes around 30% to India's GDP, 45% to manufacturing output and 48% to exports. The committee further noted that the credit gap in the MSME sector is estimated at ₹20-25 lakh crore.

DIVESTMENT, DIVIDEND TARGETS MAY STAY SAME >> 13

CGTMSE may be Enhanced >> 12

Cabinet nod for 10,000 electric buses in 169 cities

PM e-bus Sewa scheme has estimated budget of ₹57,613 crore, of which Centre will provide subsidies worth ₹20,000 crore; 181 cities without organised bus services will get green mobility infrastructure

- Out of ₹57,613 crores, ₹20,000 crores will be provided by the Central government.
- The scheme will cover cities with 3 lakhs and above population.
- Under this scheme :-
- city bus operations with 10,000 e-buses on Public Private Partnership (PPP) model will be done.
- This scheme will support bus operations for 10 years.



CABINET DECISIONS
26 April 2023

Policy for the Medical Devices Sector



- Cabinet approves the Policy for the Medical Devices Sector.
- Six Strategies planned to tap the potential of the Sector, with the Implementation Action Plan.
- Medical Devices Sector is expected to grow from present \$11 Bn to \$50 Bn in next five years.
- The policy is expected to meet the public health objectives of access, affordability, quality and innovation.

#CabinetDecisions

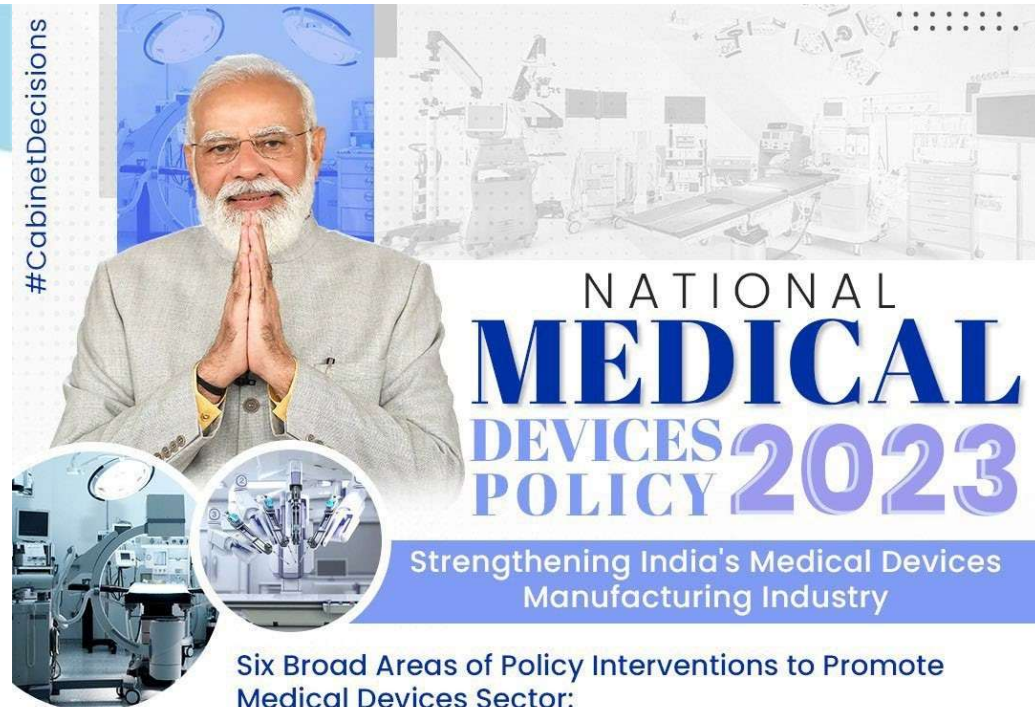

NATIONAL MEDICAL DEVICES POLICY 2023

Strengthening India's Medical Devices
Manufacturing Industry

Six Broad Areas of Policy Interventions to Promote
Medical Devices Sector:

-  Regulatory Streamlining
-  Enabling Infrastructure
-  Facilitating R&D and Innovation
-  Attracting Investments Through Private Investments, Series of Funding from Venture Capitalists & PPP
-  Human Resources Development
-  Brand Positioning and Awareness Creation

BOOSTING INDIGENOUS PRODUCTION OF GREEN FUEL



Encouraging entrepreneurship, strengthening the rural economy

5000 CBG PLANTS



To be set up under Sustainable Alternative Towards Affordable Transportation initiative by 2023-24



₹2 Lakh Crore
Investment potential



15 MMT
Compressed bio-gas production



75,000
Direct employment opportunities



Facilitating reduction in import bills



Enhancing farmers' income



Sustainable Alternative Towards Affordable Transportation (SATAT)



A New Revolution in Transportation Fuel
Compressed Bio-Gas



Boosting availability of alternate fuel



5,000
CBG plants by 2023-24



15 MMT
CBG production



75,000
Direct employment opportunities



Enhancing income of farmers





An initiative by Ministry of Petroleum and Natural Gas (MoPNG)

[Home](#)

[Participation](#)

[Developments](#)

[Contact Us](#)

[Existing User](#)



A Step Towards A Sustainable Future

SATAT

'SATAT' scheme on Compressed Bio Gas (CBG) encourages entrepreneurs to set up CBG plants, produce & supply CBG to Oil Marketing Companies (OMCs) for sale as automotive & industrial fuels.

Promoted by -



SATAT Highlights*

LOIs Issued

4090

Plants Commissioned

46

CBG Quantity Sold

16164 Tonnes

*As of March 2023



CABINET DECISIONS
04 JANUARY 2023

NATIONAL GREEN HYDROGEN MISSION

Cabinet approves National Green Hydrogen Mission with initial outlay of **Rs. 19,744 crore.**

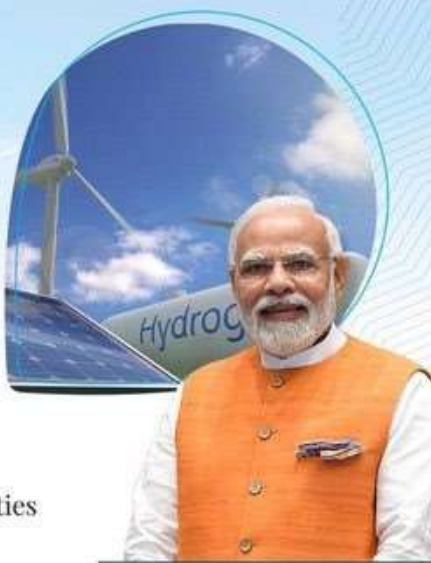

Benefits

- Creation of export opportunities for Green Hydrogen and its derivatives
- Decarbonization of industrial, mobility and energy sectors
- Reduction in dependence on imported fossil fuels and feedstock
- Development of indigenous manufacturing capabilities
- Creation of employment opportunities
- Development of cutting-edge technologies

NATIONAL GREEN HYDROGEN MISSION



NODAL MINISTRY

- Ministry of New and Renewable Energy

OBJECTIVE

- Decarbonise energy/industrial/mobility sector
- Develop indigenous manufacturing capacities
- Create export opportunities for GH₂ and its derivative

COMPONENTS OF NGHM

- Strategic Interventions for Green Hydrogen Transition Programme (SIGHT)
- Strategic Hydrogen Innovation Partnership (SHIP) (PPP for R&D)

GH₂ is not commercially viable at present; current cost in India is around ₹350-400/kg. The National Hydrogen Energy Mission aims to bring it down under ₹100/kg.

Expected Outcomes by 2030

- Atleast 5MMT GH₂ annual production
- Rs 1 lakh crore fossil fuel import savings
- 6 lakh jobs
- 50MMT CO₂ annual emissions averted
- ₹ 8 lakh crore investment

HYDROGEN AND GREEN HYDROGEN

Hydrogen is the most common element in nature but exists only in combination with other elements. It has to be extracted from naturally occurring compounds (like water).

Green Hydrogen (GH₂) is made by splitting water through an electrical process called electrolysis, using an electrolyser powered by renewable energy (RE).

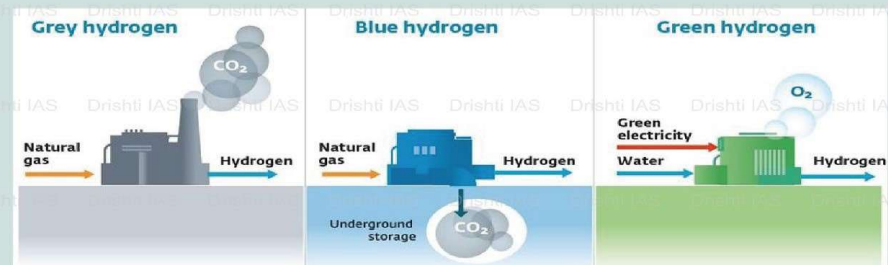

FUNDING & SUBSIDY:

Non-Government Entities:



The logo for the International Year of Millets 2023 features the text "INTERNATIONAL YEAR OF MILLETS 2023" in a stylized, bold font. "INTERNATIONAL" and "2023" are in white with blue outlines, while "YEAR OF" is smaller and in white with a blue outline. "MILLETS" is the largest word, in yellow with a blue outline. The text is set against a circular blue background with white concentric lines. Yellow and white floral or grain-like patterns are scattered around the logo.

INTERNATIONAL YEAR OF MILLETS 2023

“India is honoured to be at the forefront of popularising Millets. Millet consumption furthers nutrition, food security and welfare of farmers”



Modi Govt Extends

Indian Footwear & Leather Development Programme 2021-26



Objective of the Scheme

 Boost to the **development of infrastructure** for the leather sector

 **Employment generation** especially for women

 Enable **sector specific skill/education** in leather clusters

 Financial outlay of **₹1,700 crore**



Modi Govt Extends

Indian Footwear & Leather Development Programme 2021-26



HOW PROCESS WILL UNFOLD

A vehicle older than 20 years, if found unfit or registration certificate is not renewed, will be de-registered



Registered owners to hand over such vehicles to a Registered Vehicle Scrapping Facility with certificate of the vehicles' registration, their PAN details, and other documents



Scrapper to verify records of the vehicles from database of the stolen vehicles and issue a Certificate of Deposit, mandatory for the owner to avail incentives



The certificate once used will be stamped "Cancelled" by the agency



Government will maintain a database of the vehicles scrapped every year

INCENTIVES FOR VEHICLE OWNERS



Scrap value: 4-6% of ex-showroom price of new vehicle to be given to the owner by the scrapping centre



Tax rebate: States may be advised to offer a road tax rebate of up to 25% for personal vehicles and up to 15% for commercial vehicles against



Discount on new vehicle: Vehicle manufacturers will be advised to give 5% discount on new vehicles against a scrapping certificate



Fee waiver: Registration fees may also be waived for purchase of new vehicle against the scrapping certificate



India's Proposed Scrappage Policy

WHEN WILL THE VEHICLES BE DEREGISTERED?



Commercial vehicles in 15 years



Private vehicles in 20 years

#BanegaSwasthIndia | ndtv.com/swasthIndia



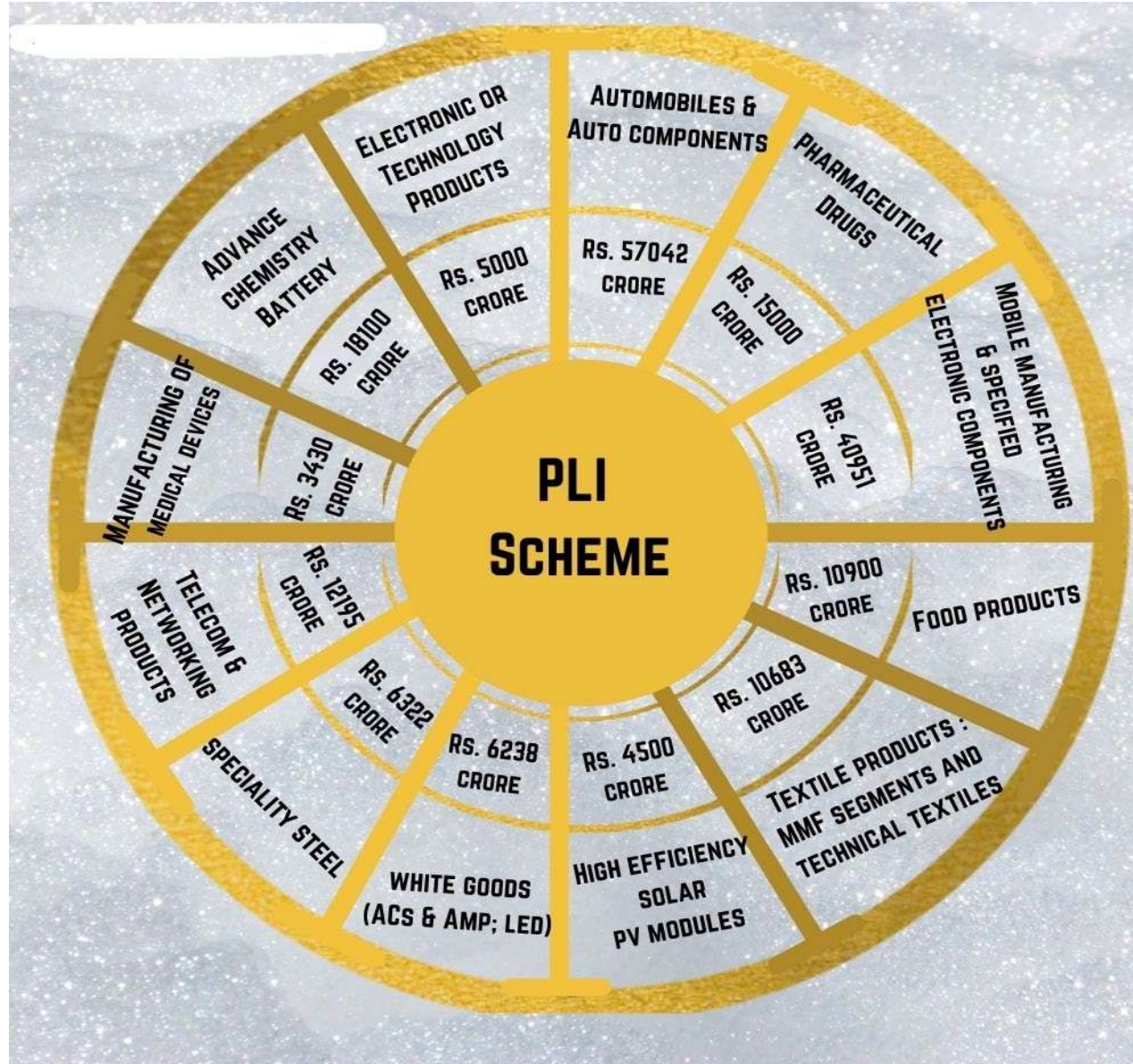

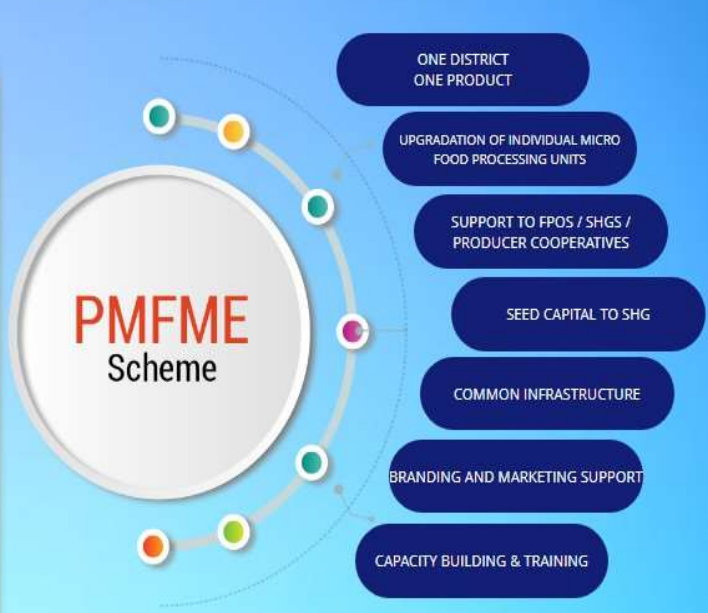

STATE

Maharashtra

State with the highest GDP in India

State Lead
Neha Kumar

CONNECT

 Subscribe To India's Growth Story

SUBSCRIBE

[HOME](#) > [ALL STATES](#) > [MAHARASHTRA](#)

THIS PAGE HAS BEEN LAST UPDATED ON - JUL 09, 2024

SNAPSHOT

Maharashtra has the Highest Nominal GDP at 14% in All-India Average Share and Highest FDI at 29%

The State capital Mumbai is the financial capital of India and houses leading corporate headquarters and firms. It also has Asia's oldest Stock Exchange, the Bombay Stock Exchange. The State houses various world heritage sites such as Ajanta, Ellora &



World's largest film industry in terms of viewership - Bollywood is based out of Mumbai



Largest producer of crude oil (offshore) in India at Bombay High



— States In India

Maharashtra

State with the highest GDP in India

Maharashtra's capital, Mumbai, is known as the financial capital of India and houses the headquarters of most of the major corporate and financial institutions. The state has a good...

INR 35 Lakh Cr

GSDP (projected),
accounting for 14% of
India's GDP (2022-23)

14%

India's GDP, Largest
GSDP in India (\$439
Bn)

INR 2.15 Lakh

Per capita income
(projected)
(2022-23)

\$69.08 Bn

FDI inflows
(Oct 2019 to Mar
2024)



State Lead
Neha Kumar

MORE ON THIS STATE



1093

Investible Projects

State Single Window





**MAHARASHTRA INDUSTRY, TRADE AND INVESTMENT
FACILITATION CELL**



- [Home](#)
- [About Us](#)
- [RTS Act](#)
- [FDI Attraction](#)
- [Investor Services](#)
- [Ease of Doing Business](#)
- [Exports](#)
- [ODOP](#)
- [News and Update](#)
- [Explore Maharashtra](#)
- [Grievance & Feedback](#)
- [Downloads](#)
- [Public Consultation](#)
- [Index of Industrial Production](#)
- [Contact us](#)

POLICIES

- [Maharashtra State Export Promotion Policy - 2023](#)
- [Maharashtra Food Processing Policy](#)
- [Electric Vehicle Policy 2021](#)
- [Liquid Medical Oxygen Policy](#)
- [Procurement Policy](#)
- [Chief Minister Employment Generation Programme \(CMEGP\)](#)
- [Electronic Policy 2016](#)
- [Start-Up Policy 2018](#)
- [Cluster policy](#)
- [Maharashtra New Industrial Policy 2019-2024](#)

Aerospace Policy	∨
Cloud Computing Policy	∨
Coir Policy	∨
Electric Vehicle Policy	∨
Fintech Policy	∨
IIA Marathi Policy	∨
Logistic Park Policy	∨
Mh Industrial policy 2013 Schedule A modification of IIA	∨
Policy for flatted gala garments gems and jewelry	∨
Telecom English	∨
Telecom Marathi	∨
Integrated and Sustainable Textile Policy 2023-28.	∨
Women Policy	∨
SC - ST Policy	∨
IT/ITES Policy 2023	∨
Industrial Policy	∨
Biotechnology Policy	∨

Special Economic Zone Policy



Single Window Policy 2016



Retail Policy 2016



Maritime Development Policy 2016



Land Acquisition Act-2013



New Maharashtra Textile Policy 2011-17



New Textile Policy 2011-17 Corrigendum



Package Scheme of Incentives , 2007



Modification of Industrial Location policy in MMR



Maharashtra's Grapes Processing Industry Policy, 2001



MAHARASHTRA EXPORT PROMOTION POLICY 2023

► Validity for !



Maharashtra aims to double its export through the new State Export Promotion Policy-2023

2.1 Vision

1

- ▶ Boost Maharashtra's global value chain participation.

2

- ▶ Achieve sustainable growth by leveraging thrust sectors and MSME exports.

3

- ▶ Diversify the export basket, exploring new markets for economic growth and job creation.

4

- ▶ Promote export-oriented food/ agro processing industries near the Samruddhi Expressway to enhance farmers' incomes.

5

- ▶ Develop every District as an Export Hub for balanced regional growth

2.2 Objectives

Double Maharashtra's exports to reach US \$150 Bn by FY 2027-28 from the current US \$72 Bn in FY 2022-23

Establish 30 World Standard Export-Oriented Industrial Parks in Maharashtra within the next 5 years.

Attain 22% of the total state participation towards the country's \$1 trillion export target by 2030.

The Zone wise financial assistance from State under (EOSP):

Zone	Taluka / Area Classification*	State Grant Contribution **	Remarks
I	A & B	40%	<ul style="list-style-type: none"> For Export Oriented Specific Projects (EOSP) projects will be supported with Grant-In-Aid as per respected zones concerned to location of the project. Grant-in-aid is limited to INR 50 Crore. Land must be with the Implementing Agency; Cost of Land will not be considered in the Project Cost. The Cost of Building (CFC, Administrative building) shall not exceed 25% of the total project cost. The cost over and above 25% shall be borne by Implementing Agency. Limited to 5 projects shall be permitted from each mentioned Zone. Total of 15 Projects in a policy period will be approved under EOSP. The projects applied under ASIDE Scheme of Govt. of India and compiling the norms of State's export promotion policy will also be eligible under EOIDP.
II	C, D, D+	50%	
III	Vidarbha, Marathwada, Ratnagiri, Sindhudurg & Dhule, Naxalism Affected Areas and Aspirational Districts as mentioned in PSI-2019 policy.	60%	

* As Per PSI 2019
** On Approved Project Cost

Ahmednagar
Dairy Products,
Sugar

Akola
Pulses, Cotton
products

Amravati
Orange, Textiles

Beed
Custard Apple,
Cotton Products

Bhandara
Rice, Mineral
based products

Buldhana
Seeds for planting,
Cotton products

Chandrapur
Rice, Bamboo
products

**Chhatrapati
Sambhajnagar**
Kesar Mango, Auto
Component

Dhule
De-oil Cake, Textile

Mumbai Suburban
Gems & Jewellery,
Marine Produce

Gadchiroli
Rice, Forest
products

Gondia
Rice, Bamboo
Article

Hingoli
Turmeric, Soyabean
based products

Jalgaon
Jalgaon Banana,
Plastic PVC Pipe

Jalna
Sweet Orange,
TMT Steel Bars

Kolhapur
Jaggery,
Engineering

Latur
Pulses, Soyabean
based products

Mumbai
Gems and
Jewellery, Leather

Nagpur
Nagpur Orange,
Engineering

Nanded
Soyabean
products,
Spices

Nandurbar
Chilli powder,
Textile

Nashik
Grapes,
Paithani Sarees

Osmanabad
Pulses, Sugar

Palghar
Chicken,
Marine Products

Parbhani
Gram (Harbhar)
Jaggery

Pune
Frozen Food,
Engineering

Raigad
Marine
Produce,
Iron & Steel

Ratnagiri
Alphonso
Mango, Marine
Produce

Sangli
Turmeric,
Pump Spares

Satara
Strawberries,
Jaggery

Sindhudurg
Devgad
Alphonso
Mango, Cashew

Solapur
Pomegranate,
Terry Towel

Thane
Millets,
Garment and
Textile

Wardha
Walgaon
Turmeric,
Cotton Yarn

Washim
Soyabean,
Cotton

Yavatmal
Cotton,
Dolomite and
Limestone

ODOP
ONE DISTRICT ONE PRODUCT
MAHARASHTRA

THANK YOU

CA SHUBHI GUPTA
+91 8802483032